



STAR WARTM



8084



1

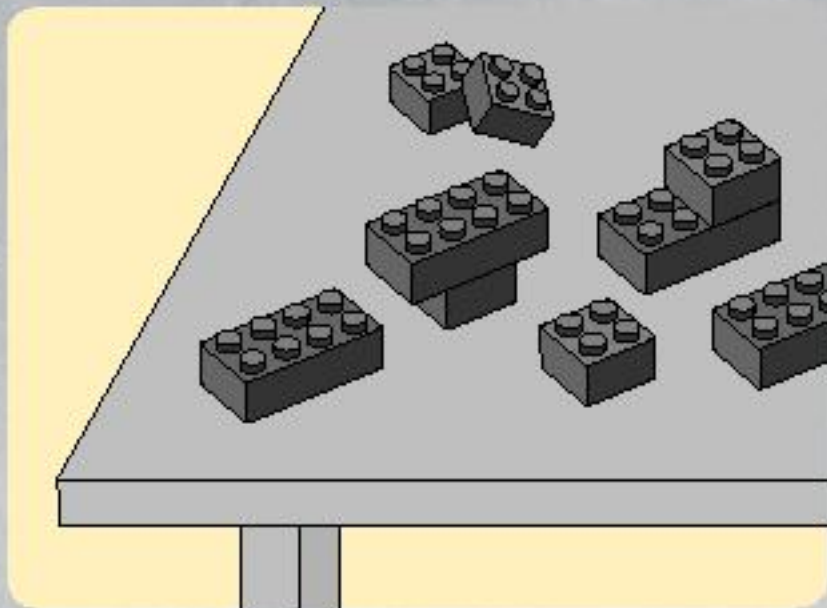
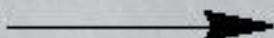

2

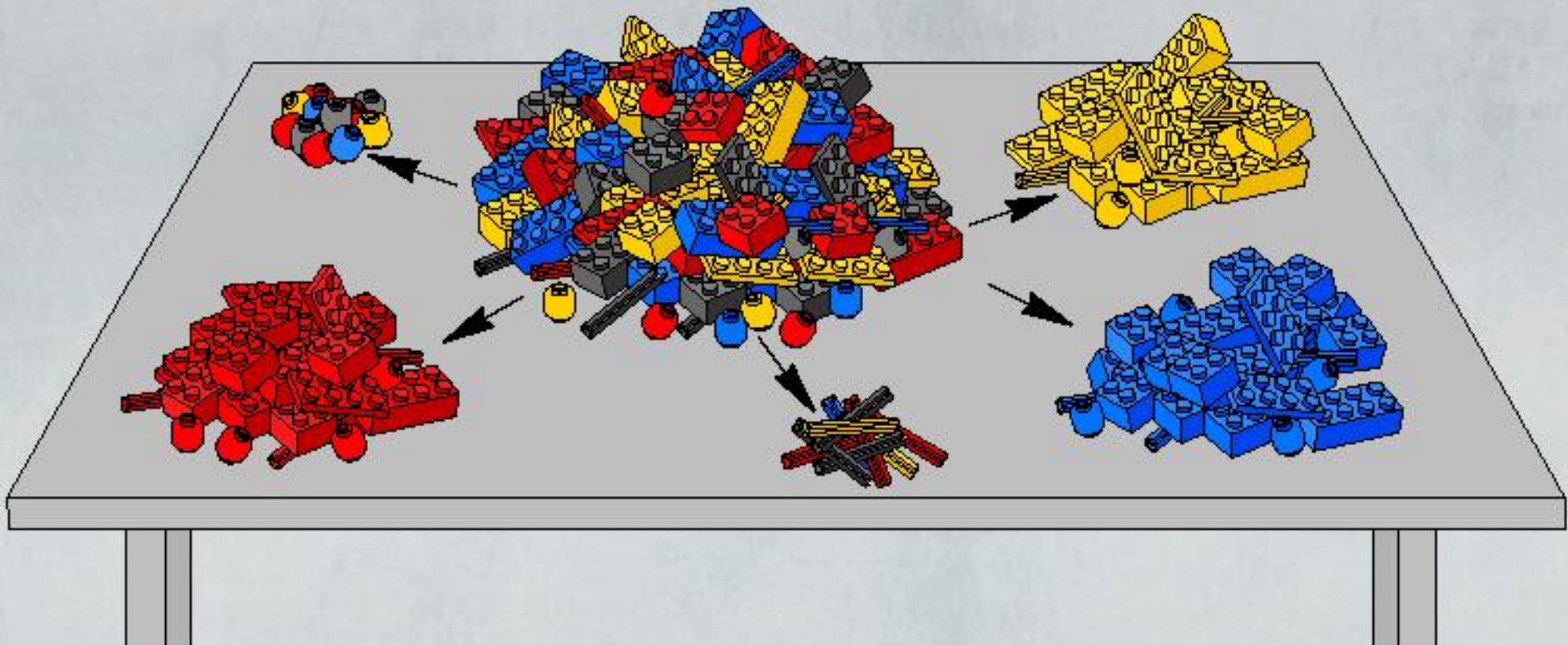

3

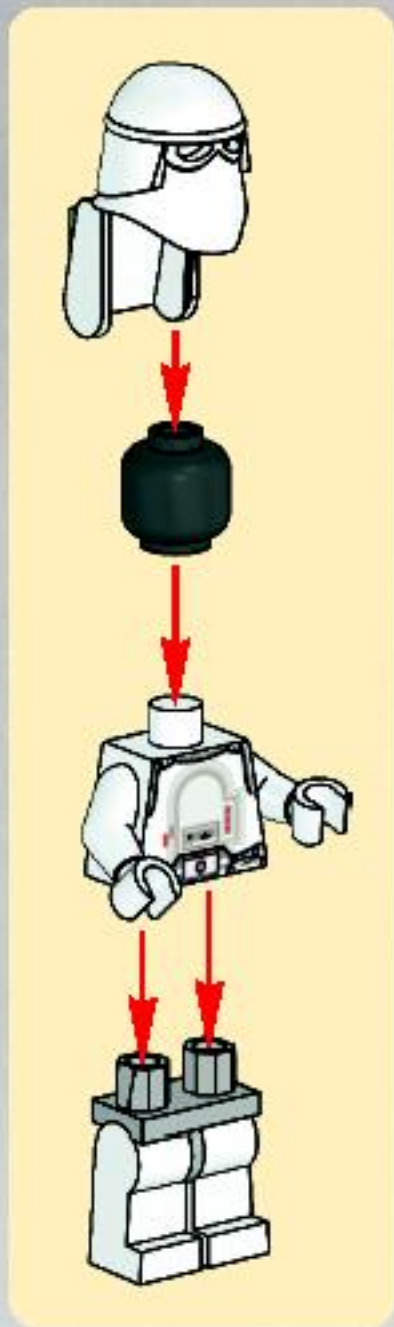



1

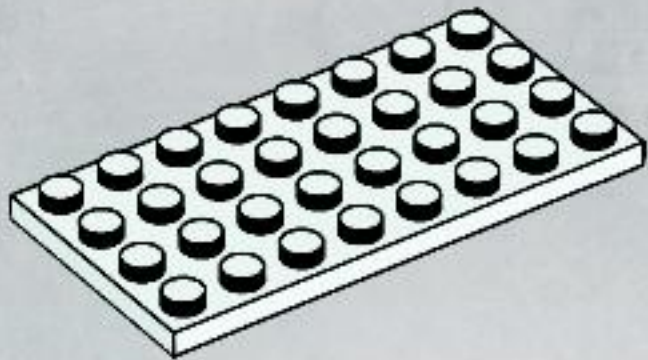

2

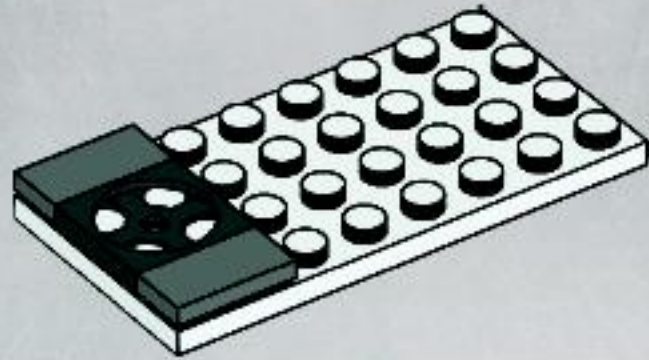

3

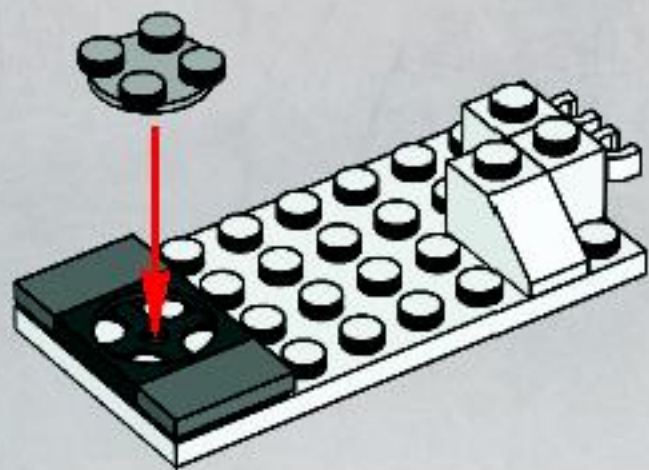

4

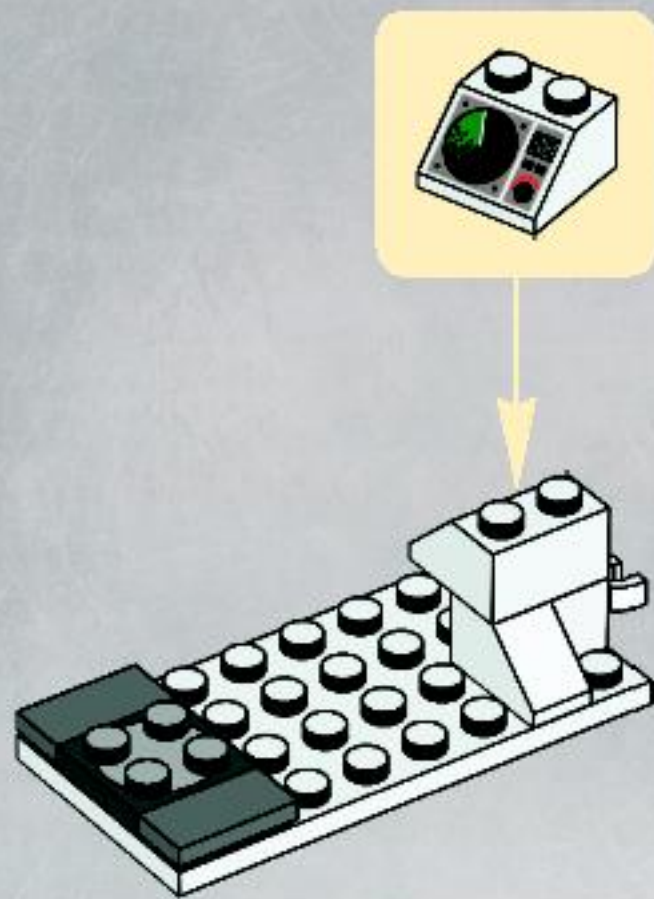

5

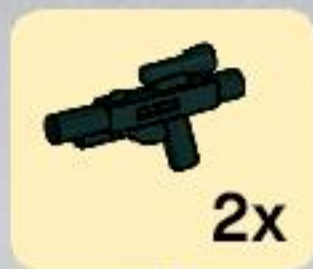
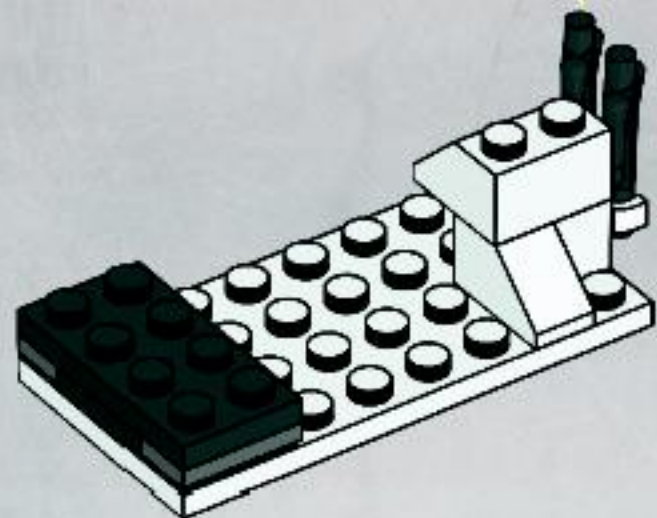

6

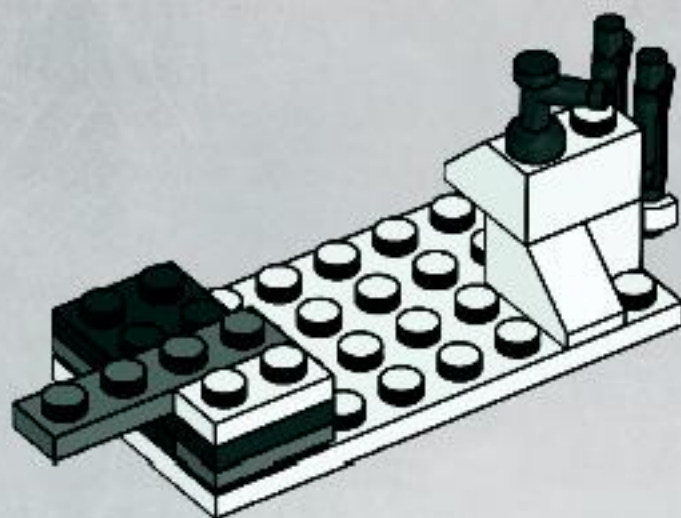

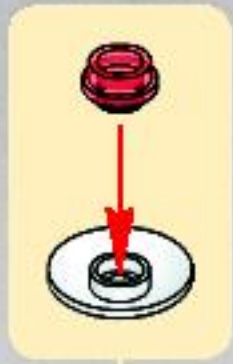

7

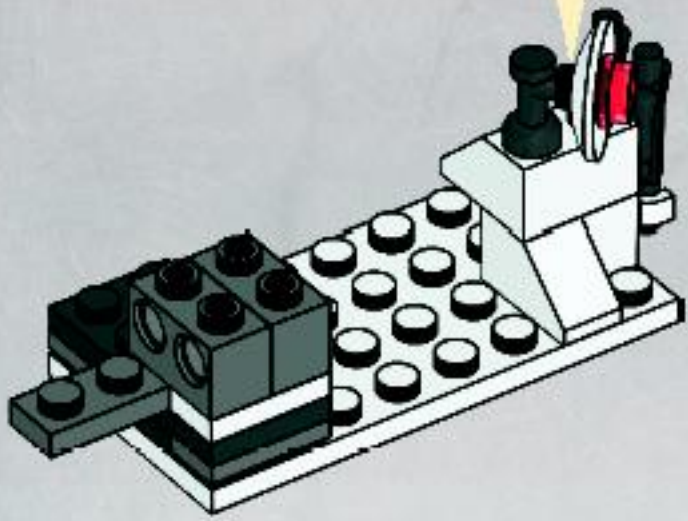

8

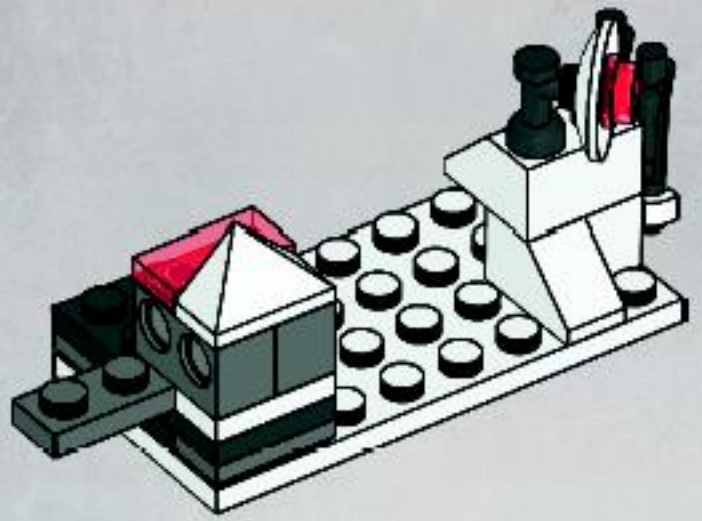

9

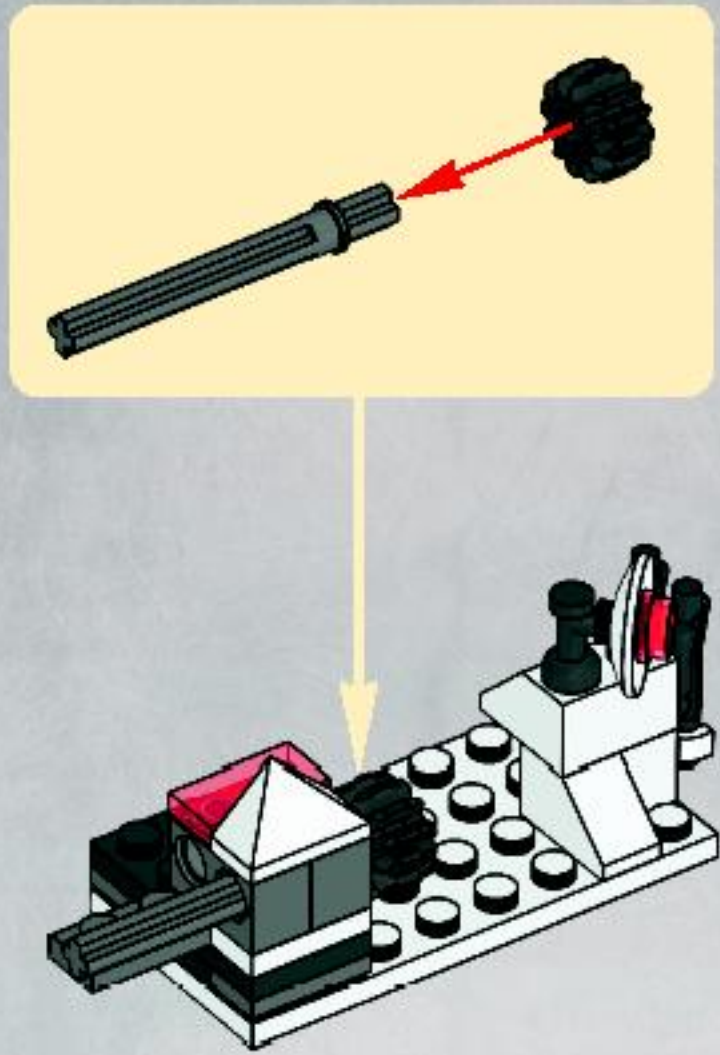

10

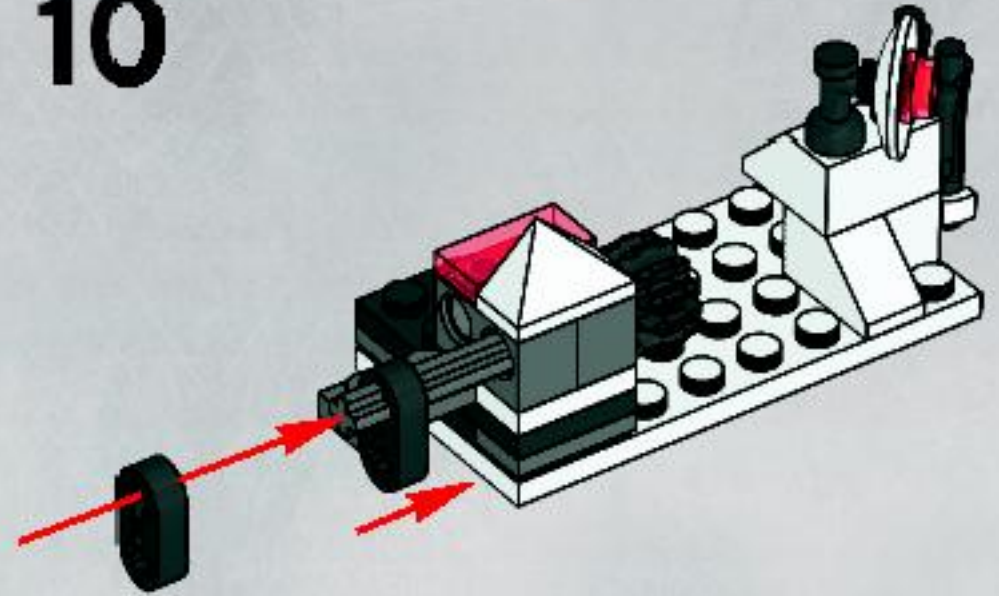



11

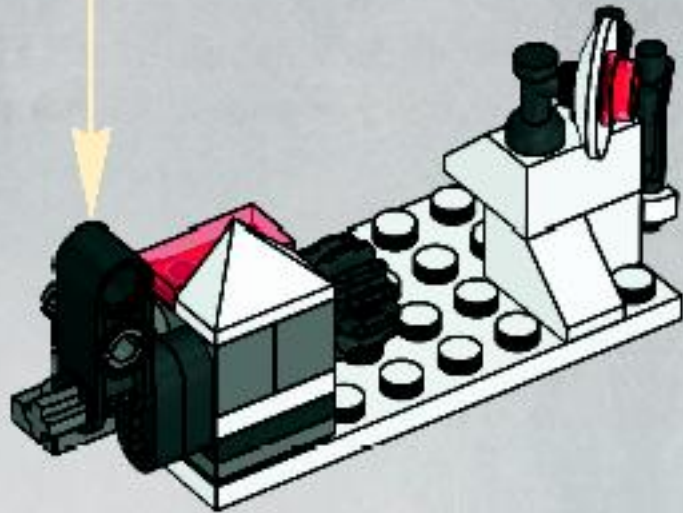

1

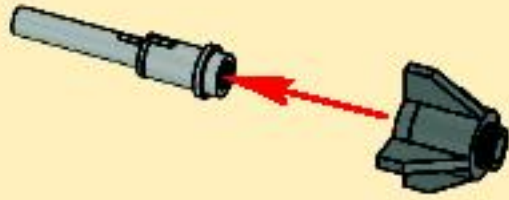

2

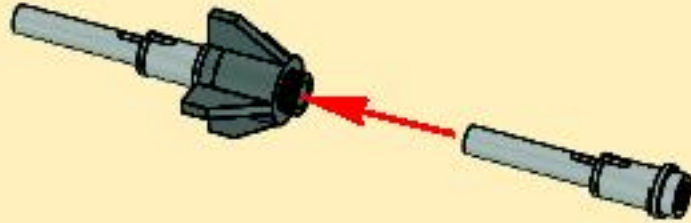

3



12

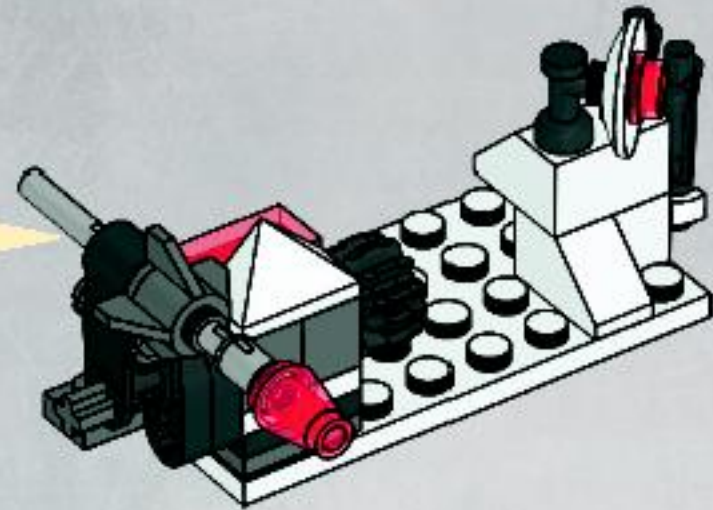

13

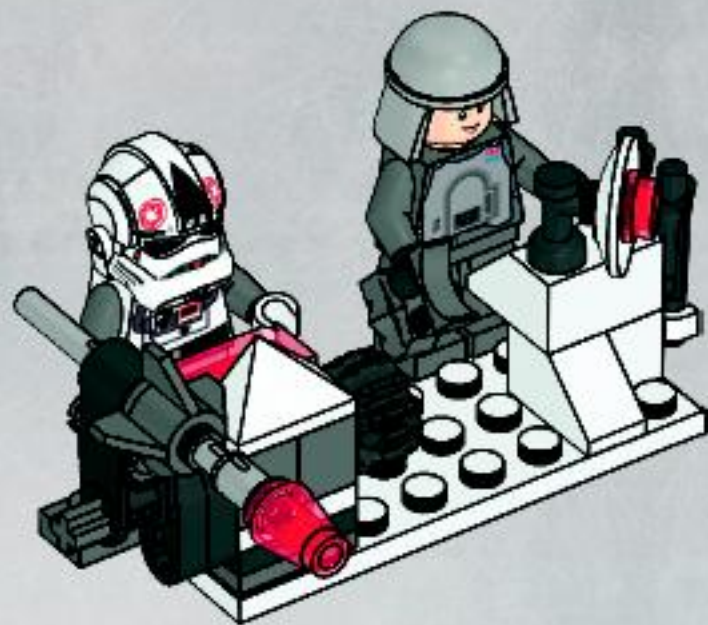

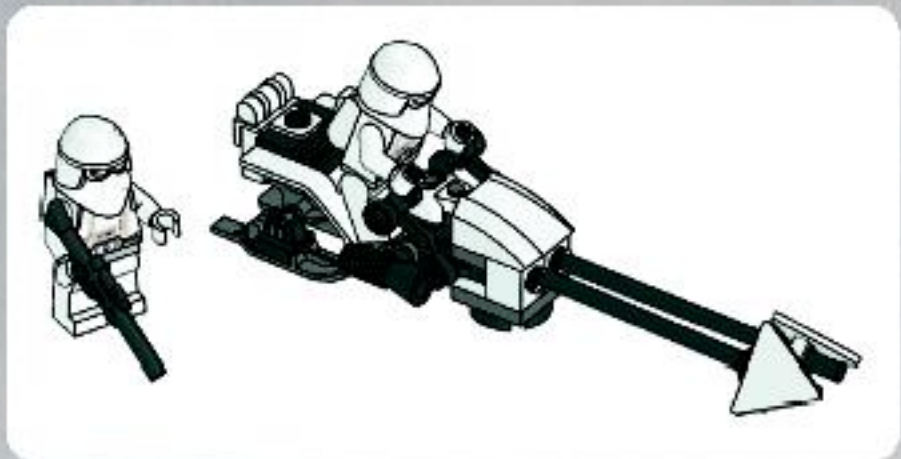

1

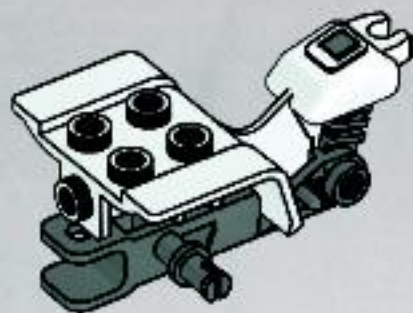

2

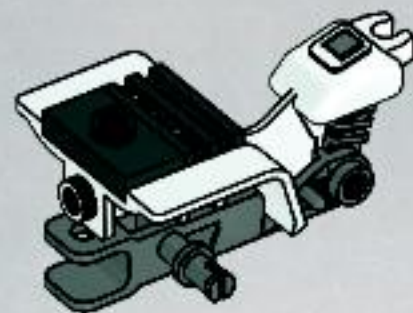



3

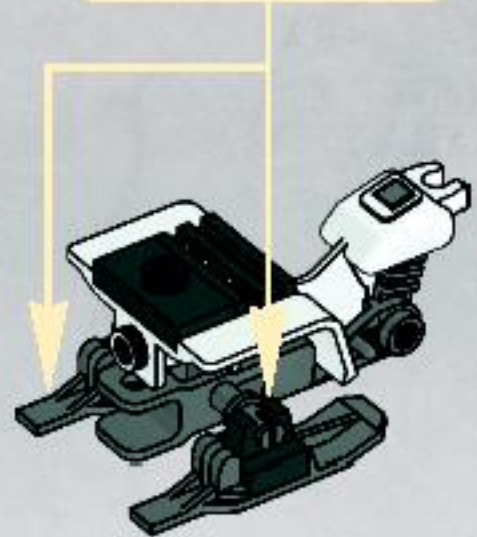

4

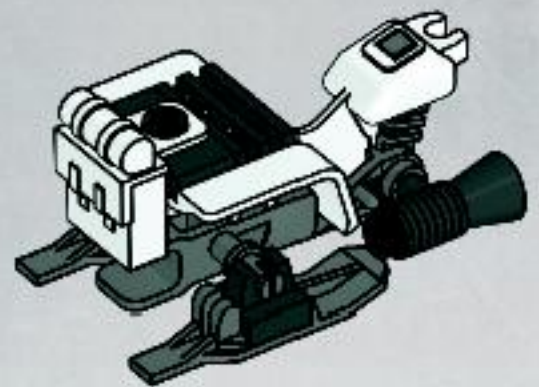

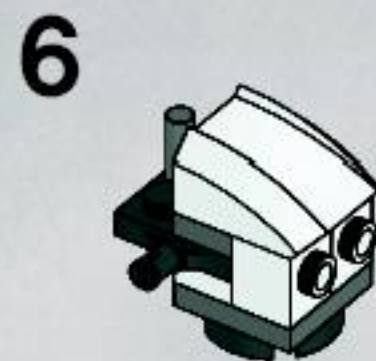
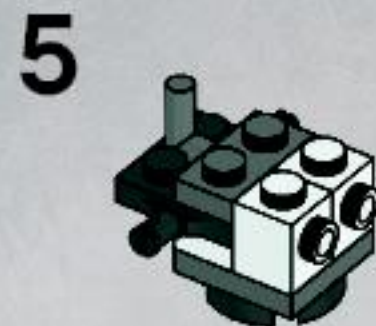
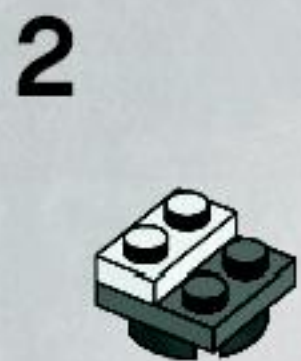
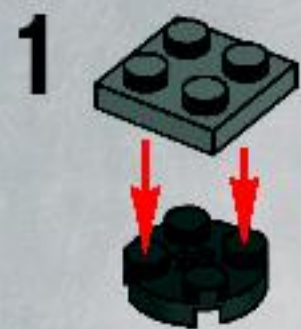

7

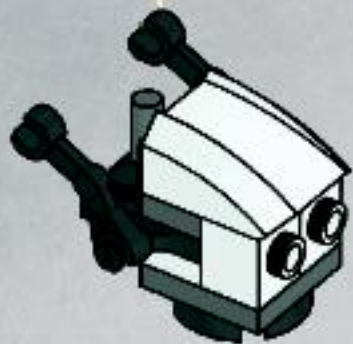

8

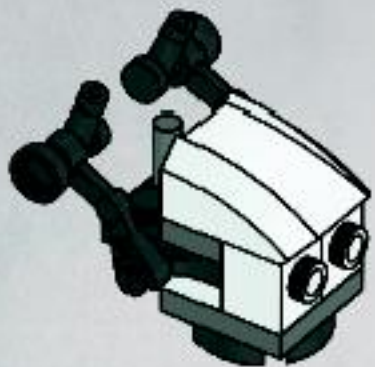

5

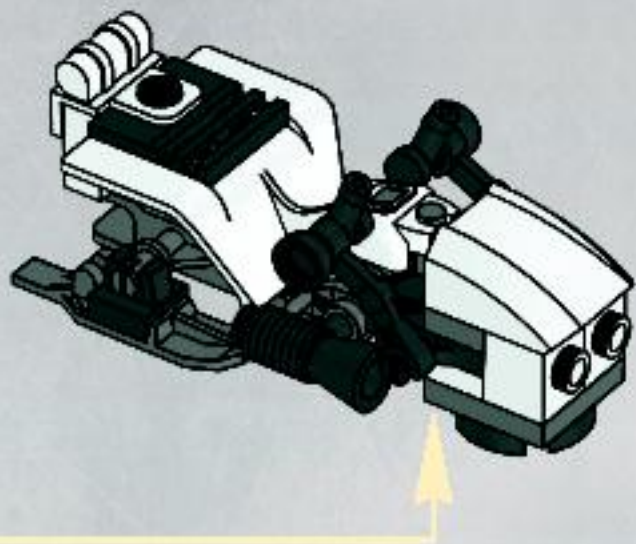

6

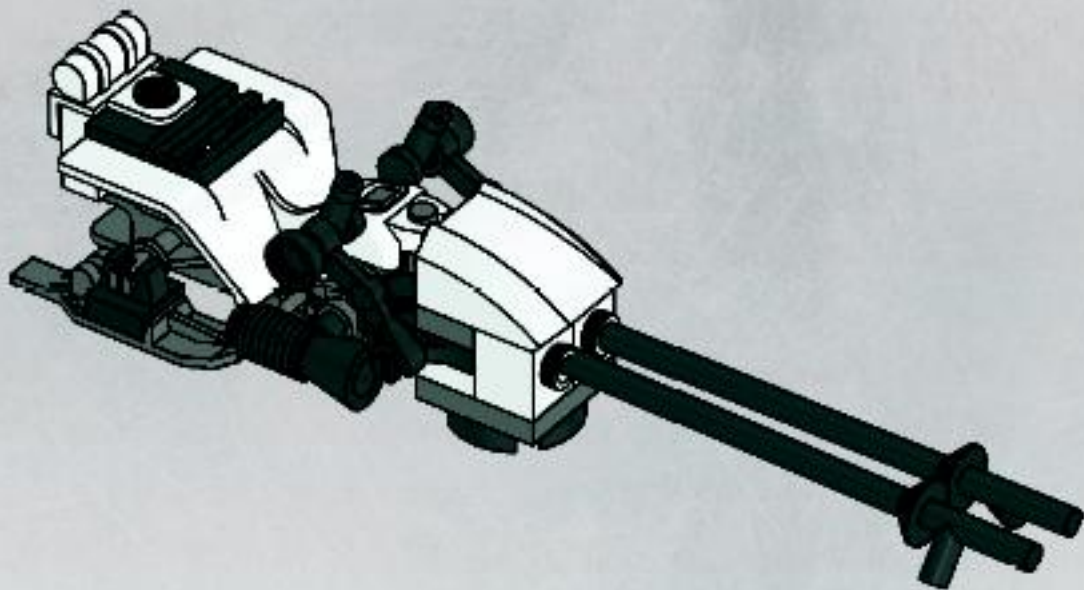

7

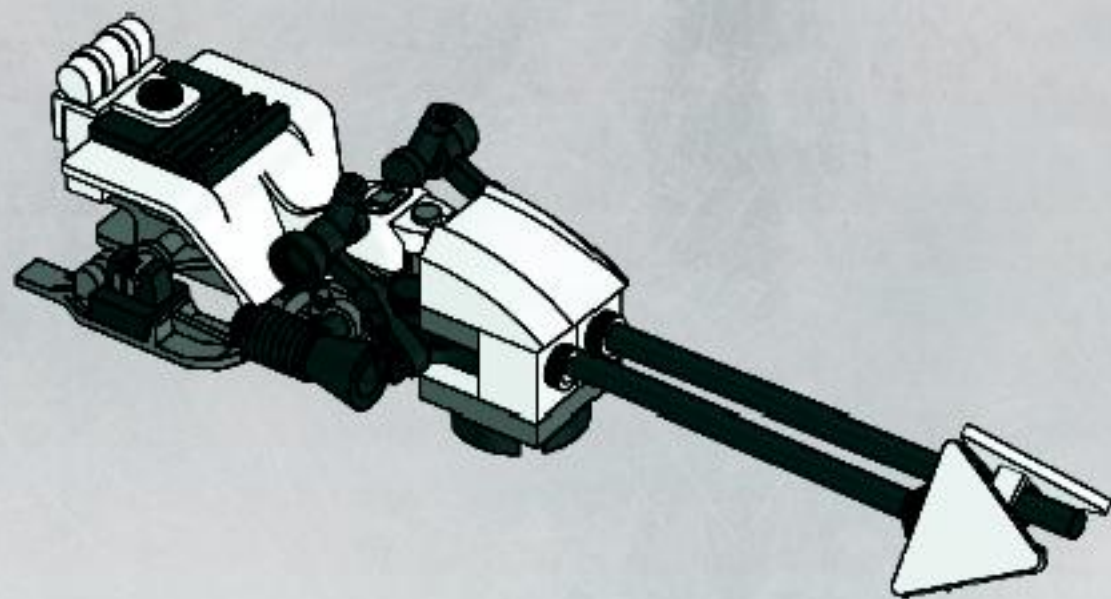

8

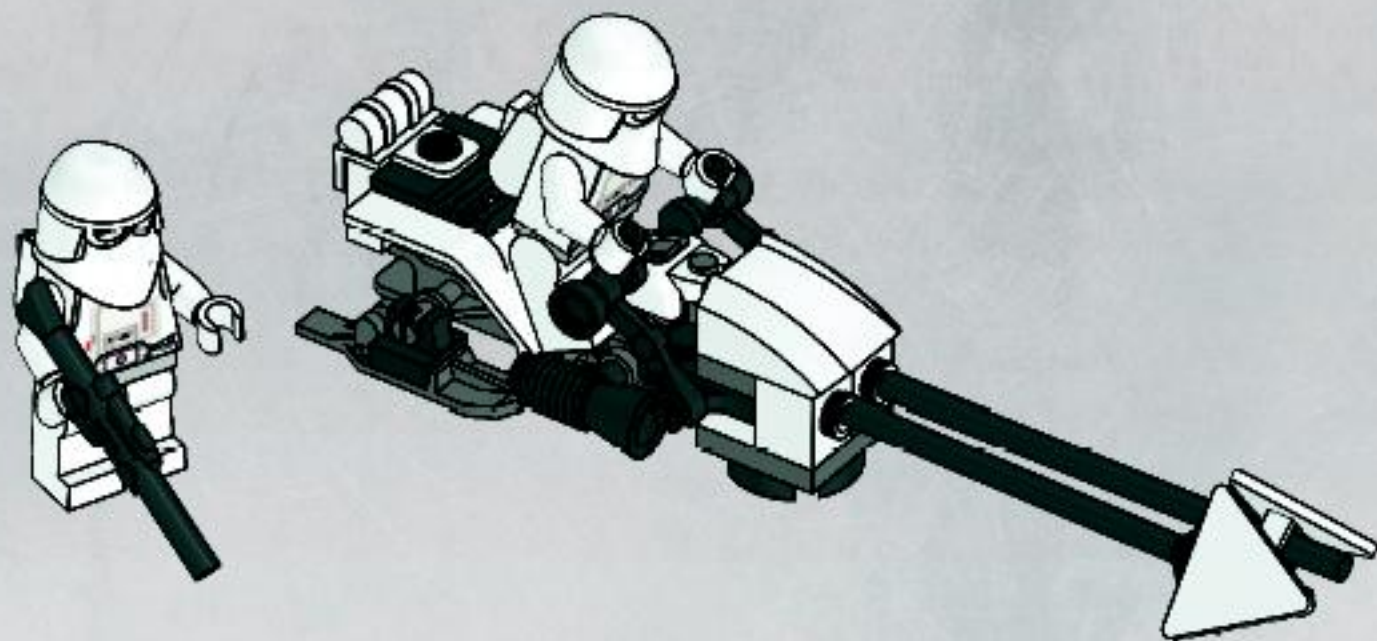

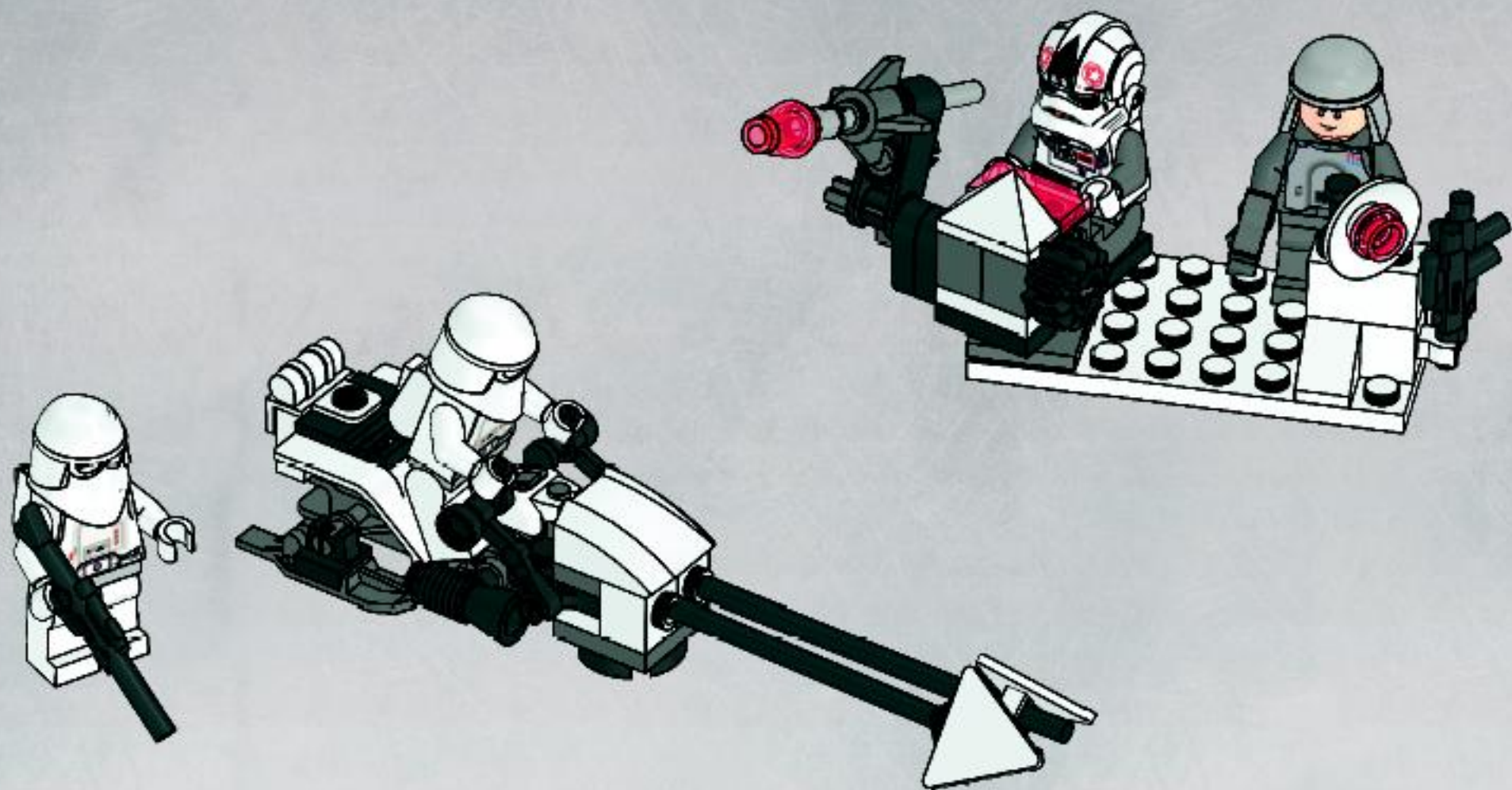



Customer Service
 Kundenservice
 Service Consommateurs
 Servicio Al Consumidor
www.lego.com/service or dial





8083

8084



8085



8086



8087



8088

FREE! GRATIS! GRATUIT!



club
MAGAZINE™

www.LEGOclub.com



00800 5346 5555*        



1-866-534-6258 • 1-877-518-5346

US & Canada only

Canada seulement

* Freephone. Mobile charges may apply. * Numéro sans Frais. Les Frais peuvent s'appliquer avec les téléphones cellulaires. * Gebührenfrei. Kosten für Anrufe aus Mobilfunknetzen können anfallen.
* Gratis telefoonnummer vanaf vastlijn. * Het erelt gratis nummer, nárdá ringer frá Postbúlaíön. * Det är gratis, nárdá ringer från ett Post-teléfono.



VISIT THE WORLD'S
BIGGEST LEGO® SHOP!

www.LEGOshop.com



WIN!

Go to www.nielsen.com/LEGO
to fill out a survey for a chance
to win a cool LEGO® Product.
No purchase necessary.
Open to all residents where not prohibited.



www.nielsen.com/LEGO

GEWINNE!

Nimm an der Umfrage auf
www.nielsen.com/
LEGO teil und hab die Chance ein cooles
LEGO® Produkt zu gewinnen!

Die Teilnahme am Gewinnspiel führt zu keinerlei
Kaufverpflichtungen. Teilnahme in allen nicht
ausgeschlossenen Ländern möglich.

WIN!

Ga naar www.nielsen.com/LEGO,
vul een enquêteformulier in en
maak kans op een
cool LEGO® product.

Geen aankoopverplichting.

Iedereen mag deelnemen, uitzonderd
ingezetenden

van landen waar een enquêteverbod geldt.

GAGNE!

Visite www.nielsen.com/LEGO
pour répondre à un questionnaire
et avoir une chance de gagner
un produit LEGO® très cool!

Aucune obligation d'achat.

Ouvert à tous les résidents des pays
autorisés.

当てよう!

www.nielsen.com/LEGO
にアクセスして、
アンケートにご記入ください。
当選者にはレゴ製品を
差し上げます。

お買い上げの金額はありません。

購止されていない限り、すべての年齢にご利用いただけます。