



STAR WARS™

75363





Get excited about our new packaging!

We're switching from plastic to paper-based packaging. That's why you might find a mix of paper and plastic in our boxes!

Nos nouveaux emballages vous emballeront !

Nous passons des emballages en plastique aux emballages à base de papier. C'est pourquoi vous pourriez trouver un mélange de papier et de plastique dans nos boîtes !

¡Te presentamos nuestros nuevos empaques!

Estamos sustituyendo las bolsas de plástico por bolsas con base de papel. ¡Por eso, puedes encontrar una mezcla de papel y de plástico en nuestras cajas!

[LEGO.com/sustainable-packaging](https://www.lego.com/sustainable-packaging)



BUILDER



Apple and the Apple logo are trademarks of Apple Inc., registered in the U.S. and other countries and regions. App Store is a service mark of Apple Inc. Google Play and the Google Play logo are trademarks of Google LLC. Tencent and the Tencent logo are trademarks of Tencent Inc.

🔍 LEGO.com/devicecheck

EN Ask parents' permission before going online | **DE** Eltern um Erlaubnis bitten, bevor du online gehst | **FR** Demande l'autorisation d'un parent avant d'aller en ligne | **IT** Chiedi il permesso ai tuoi genitori prima di andare online | **ES** Pídeles permiso a tus papás antes de conectarte a Internet | **PT** Pede autorização aos pais antes de acederes online | **ZH** 上网前应先征得父母的同意 | **PL** Poproś rodziców o zgodę, zanim wejdiesz do Internetu | **CS** Než půjdeš na internet, požádej rodiče o svolení | **SK** Skôr než pôjdeš na internet, vypýtaj si povolenie od rodičov | **HU** Kérj szülői engedélyt, mielőtt online csatlakoznál! | **RO** Cere permisiunea părinților înainte de a te conecta online | **BG** Поискайте разрешение от родител, преди да влезете онлайн | **LV** Pirms došanās tiešsaistē palūdz atļauju vecākiem | **ET** Enne Interneti kasutamist küsi vanematelt luba | **LT** Prieš prisijungdami prie interneto, atsiklauskite tėvų



1

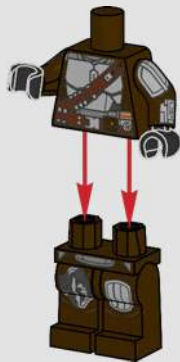

4



2

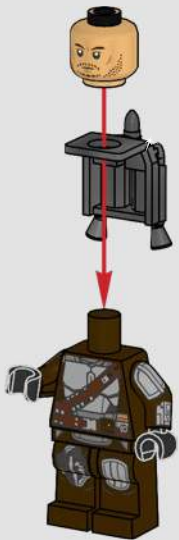

3

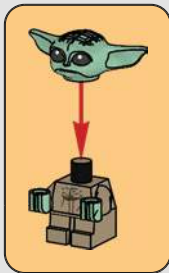



1x

1

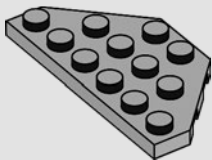

6





2x

2

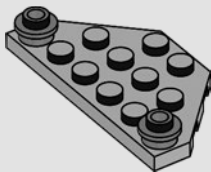



1x

3

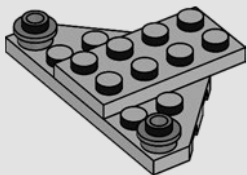

8





1x

4

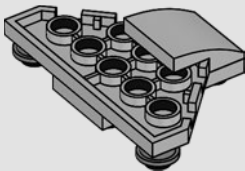



2x

5

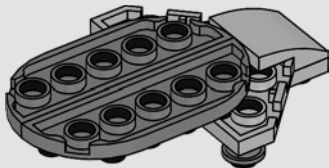

10





6

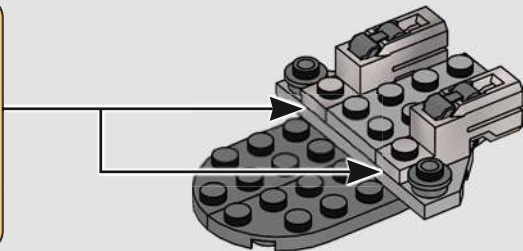
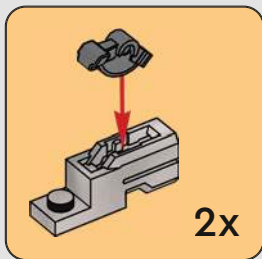



1x



1x

7

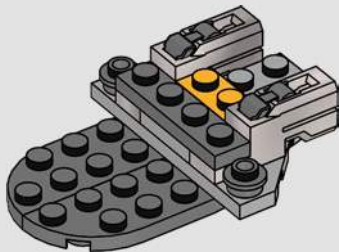



1x

8

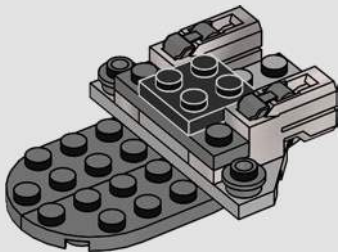



2x

9



2x

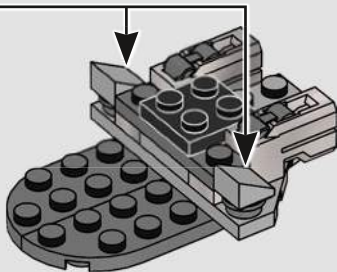

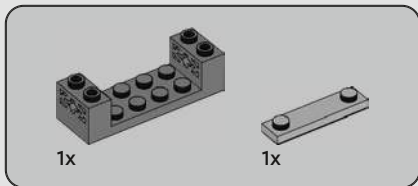

10

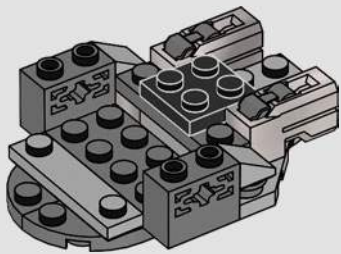



2x

11



2x

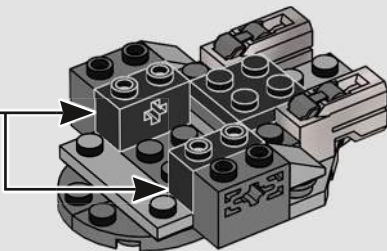



2x

12

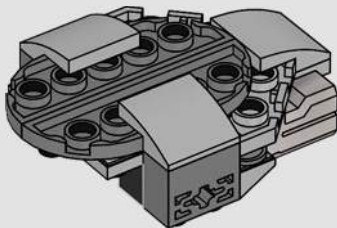



1x



1x



1x



1x



1x



1x



1x

1

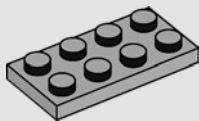

13



2

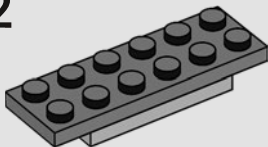

3

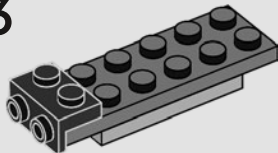

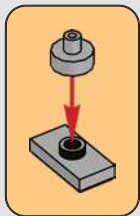

4

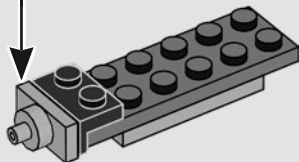

5

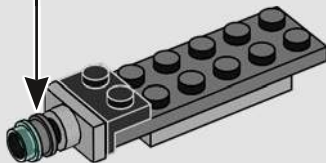

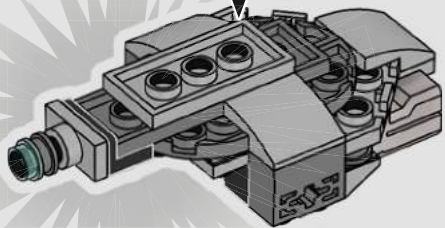



1x



1x

14

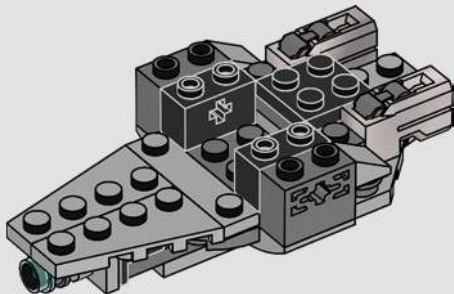



2x

15

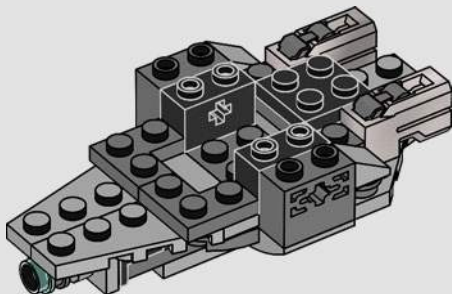



2x

16

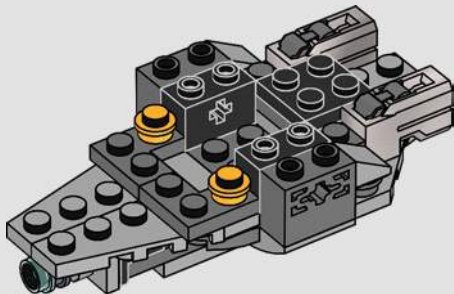



2x

17

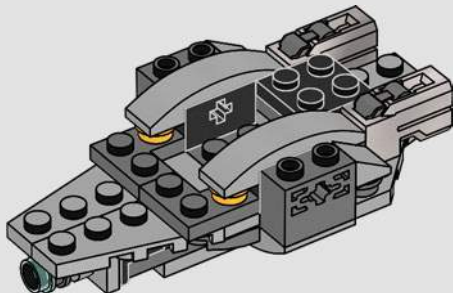



2x

18

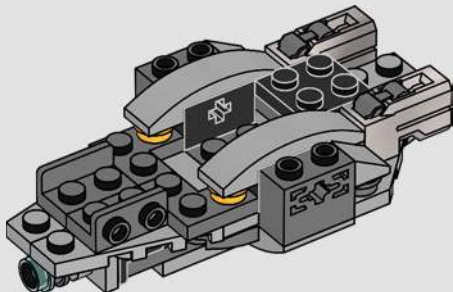



1x

19

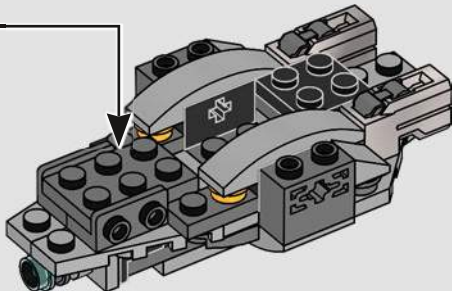



2x

20

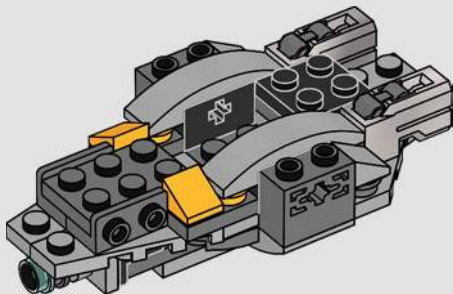



2x

21



2x

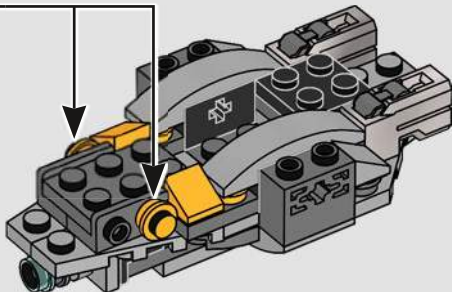



2x

22

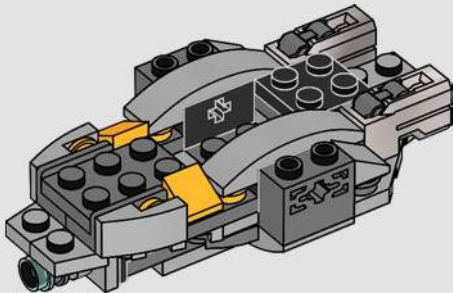



1x



1x



1x

23

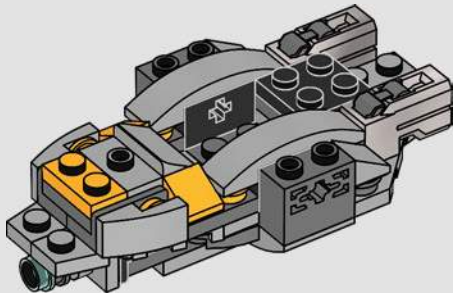



1x

24

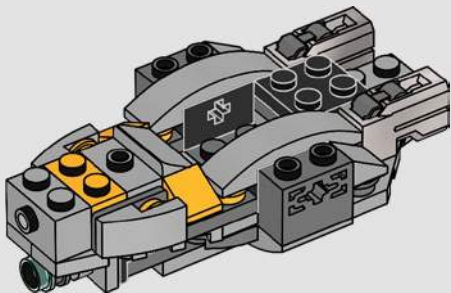



2x

25

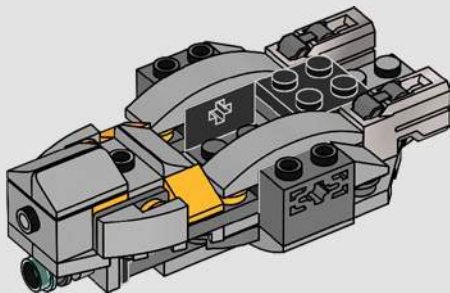



1x

26

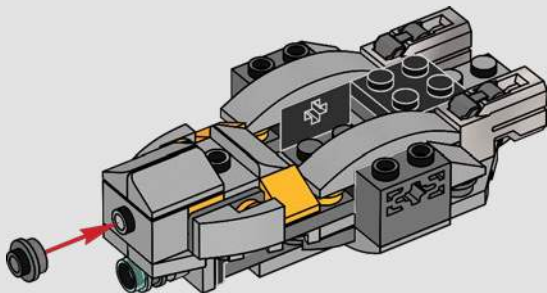

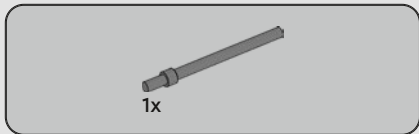

27

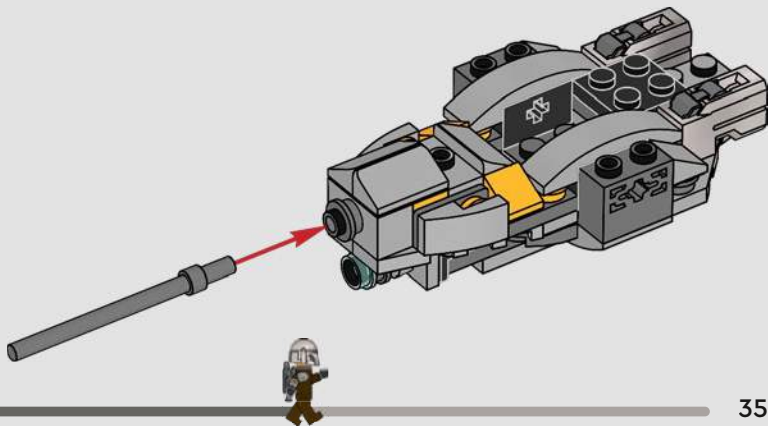



1x



1x

28

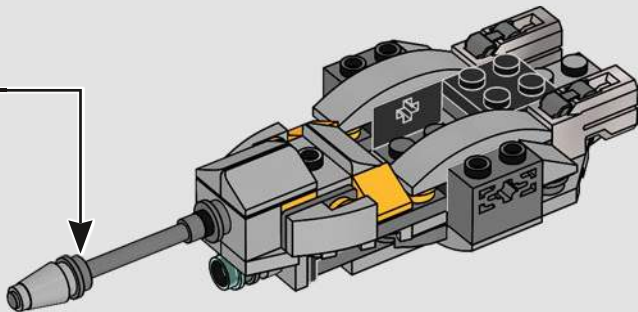
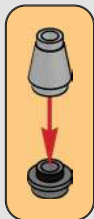



2x

29

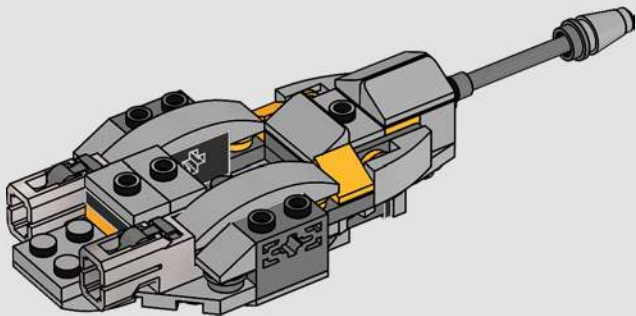



1x



1x

30

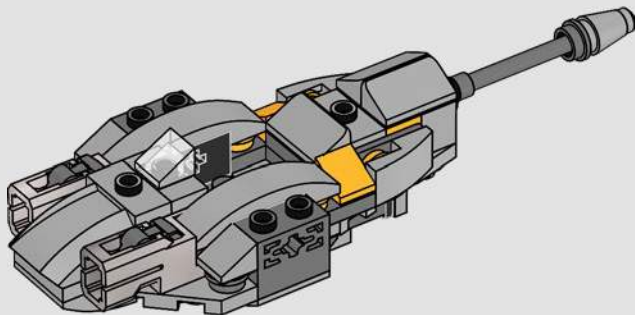



2x



1x



1x

31



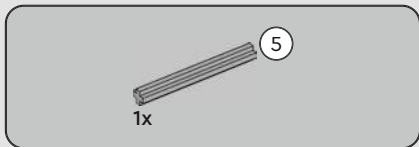

32

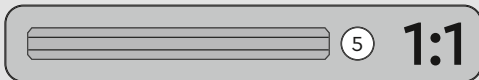
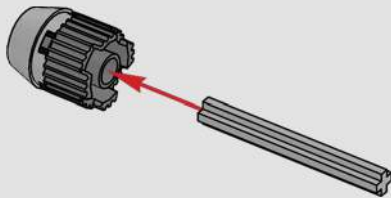



1x

33

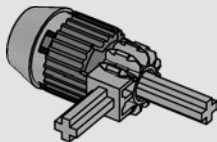

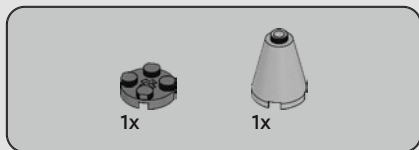

34

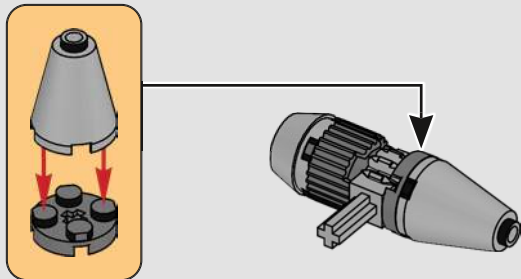

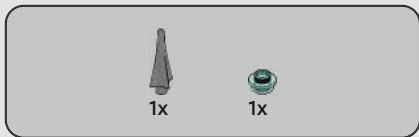

35

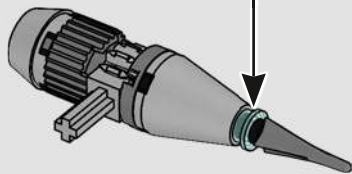
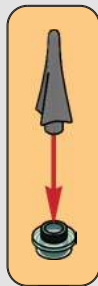

2x



36

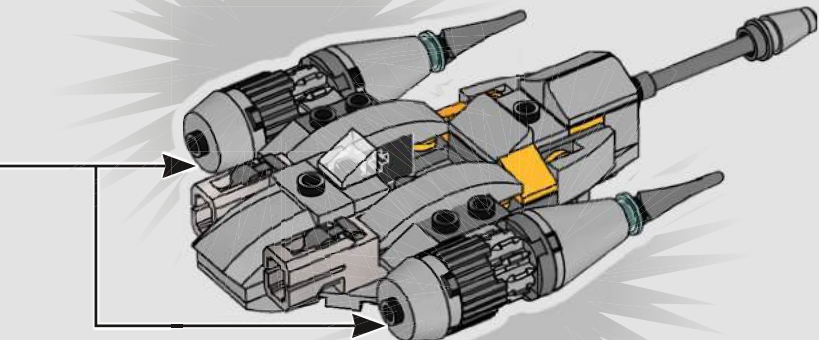



4x



37

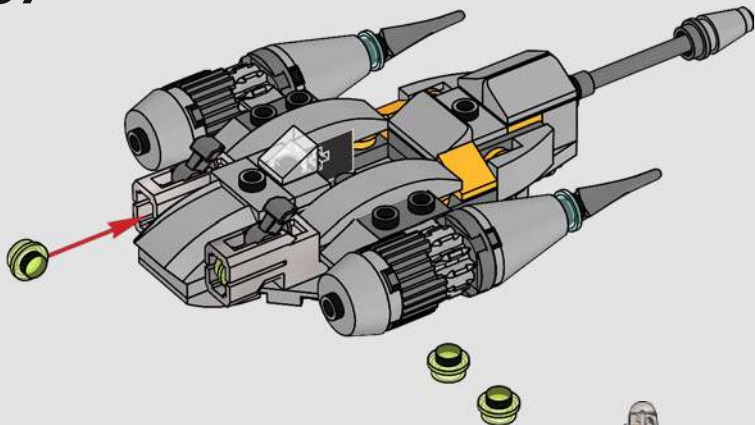

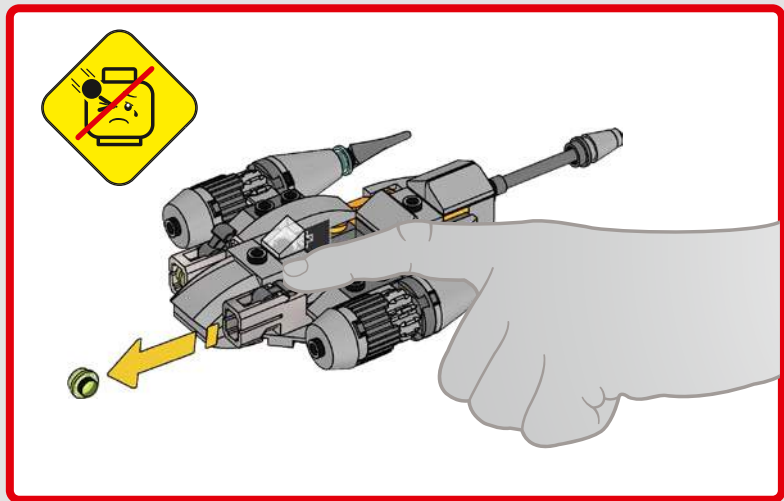





STAR WARS™



75346



75348



75363



75344



75361



STAR WARS™



75368



75369



75370



2x
6178922



2x
6023173



2x
6028324



1x
6257593



1x
6258831



1x
302226



2x
6028736



2x
4521921



2x
4211395



4x
6066097



4x
6331261



3x
4568637



1x
4211735



1x
4162889



1x
6016172



1x
6383177



2x
6028813



1x
4211732

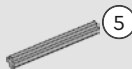

2x
4211639



1x
6360207



1x
4529241



3x
6185676



1x
4211352



2x
6134848



1x
6245250



2x
6404367



2x
4622803

5



2x
6000606



1x
4211043



5x
6231765



1x
6336925



1x
6406230



1x
4211001



2x
4211042



1x
6467193



1x
6328209



2x
6345950



1x
6170420



2x
4210635



1x
6356454



4x
6240206



3x
6283590



1x
6454959



2x
6360675



1x
6327440



4x
6240206



2x
6269969



1x
6330212



1x
4211002



2x
6388294



LEGO.com/service

YOU COULD **WIN**



Scan this QR code or go to
LEGO.COM/PRODUCTFEEDBACK and give us
your short feedback about this LEGO® set
for a chance to win a cool LEGO prize.

Terms and Conditions apply*



EN: YOU COULD WIN. Terms and Conditions apply* **DE: Du könntest GEWINNEN.** Es gelten die Teilnahmebedingungen* **FR: Tu pourrais GAGNER.** Des conditions s'appliquent* **IT: Potresti VINCERE tu.** Termini e condizioni sono applicabili* **ES: Puedes GANAR.** Aplican términos y condiciones* **PT: Poderá GANHAR.** Aplicam-se termos e condições* **ZH: 轻松获奖.** 条款和条件适用* **PL: Szansa na WYGRANĄ.** Obowiązują warunki korzystania* **CS: Máte šanci VYHRÁT.** Platí všeobecné smluvní podmínky* **SK: Máte šancu VYHRÁŤ.** Platia všeobecné zmluvné podmienky* **HU: TE IS NYERHETSZ.** Felhasználási feltételek érvényesek* **RO: Ai putea CÂȘTIGA.** Se aplică termeni și condiții* **BG: Можете да СПЕЧЕЛИТЕ.** Има определени правила и условия* **LV: Tu vari LAIMĒT.** Ir spēkā noteikumi un nosacījumi.* **ET: Sul on võimalus VÕITA.** Kehtivad tingimused* **LT: Jūs galite LAIMĖTI.** Taikomos sąlygos*

*[LEGO.com/productfeedback-terms](https://www.lego.com/productfeedback-terms)

LEGO and the LEGO logo are trademarks of the/son des marques de commerce du/
son marcas registradas de LEGO Group. ©2023 The LEGO Group.

© & ™ Lucasfilm Ltd.

6476589