



# STAR WARS™

75359





## **Get excited about our new packaging!**

We're switching from plastic to paper-based packaging. That's why you might find a mix of paper and plastic in our boxes!

## **Nos nouveaux emballages vous emballeront !**

Nous passons des emballages en plastique aux emballages à base de papier. C'est pourquoi vous pourriez trouver un mélange de papier et de plastique dans nos boîtes !

## **¡Te presentamos nuestros nuevos empaques!**

Estamos sustituyendo las bolsas de plástico por bolsas con base de papel. ¡Por eso, puedes encontrar una mezcla de papel y de plástico en nuestras cajas!

**[LEGO.com/sustainable-packaging](https://www.lego.com/sustainable-packaging)**



# BUILDER



Apple and the Apple logo are trademarks of Apple Inc., registered in the U.S. and other countries and regions. App Store is a service mark of Apple Inc. Google Play and the Google Play logo are trademarks of Google LLC. Tencent and the Tencent logo are trademarks of Tencent Inc.

 [LEGO.com/devicecheck](https://www.lego.com/devicecheck)

**EN** Ask parents' permission before going online | **DE** Eltern um Erlaubnis bitten, bevor du online gehst | **FR** Demande l'autorisation d'un parent avant d'aller en ligne | **IT** Chiedi il permesso ai tuoi genitori prima di andare online | **ES** Pídeles permiso a tus papás antes de conectarte a Internet | **PT** Peça autorização aos pais antes de acederes online | **ZH** 上网前应先征得父母的同意 | **PL** Poproś rodziców o zgodę, zanim wejdiesz do Internetu | **CS** Než půjdeš na internet, požádej rodiče o svolení | **SK** Skôr než pôjdeš na internet, vypýtaj si povolenie od rodičov | **HU** Kérj szülői engedélyt, mielőtt online csatlakoznál! | **RO** Cere permisiunea părinților înainte de a te conecta online | **BG** Поискайте разрешение от родител, преди да влезете онлайн | **LV** Pirms došanās tiešsaistē palūdz atļauju vecākiem | **ET** Enne Interneti kasutamist küsi vanematelt luba | **LT** Prieš prisijungdami prie interneto, atsiklauskite tėvų



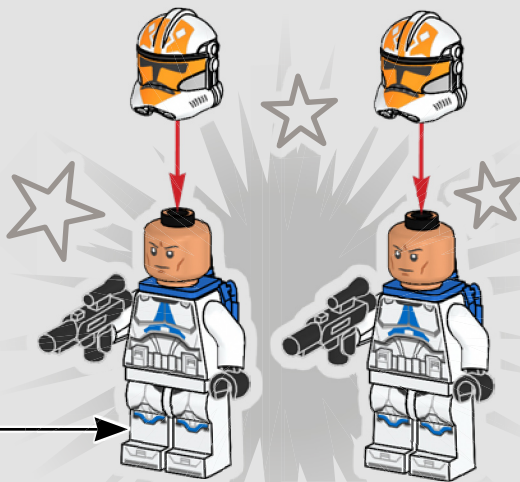
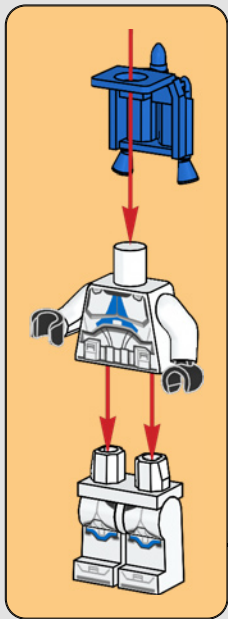

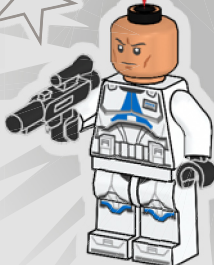
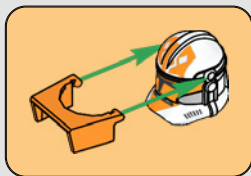



1x



1x



2x



1x



1x



1x

1

1



2



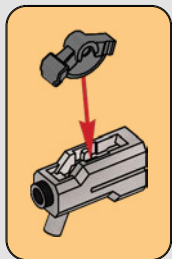

3

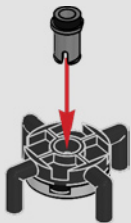

4

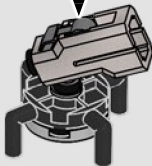

5

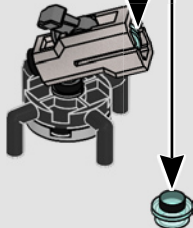



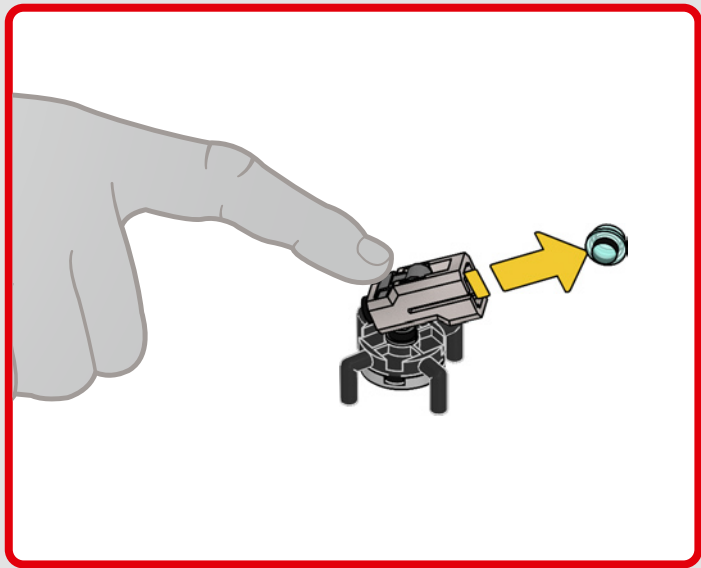

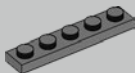
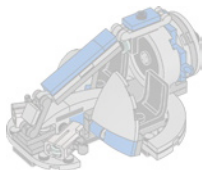

1x

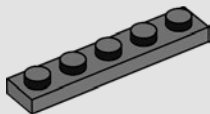

1

10





1x

2

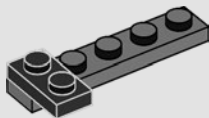



1x

3

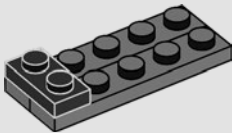



1x

4

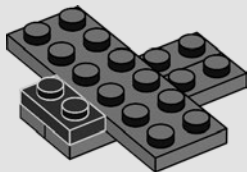



2x

5

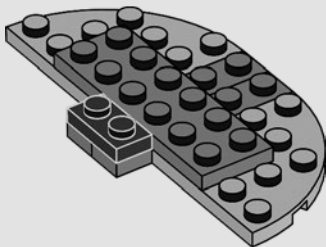



2x

6

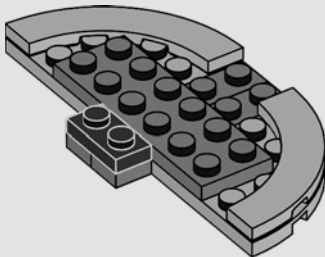



1x

7

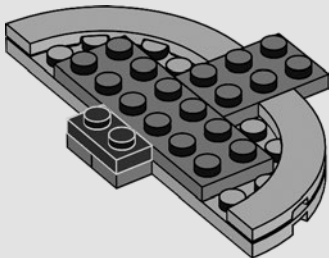





1x

8

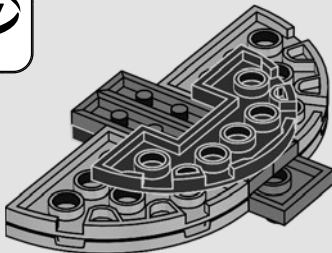

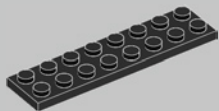

1x

9

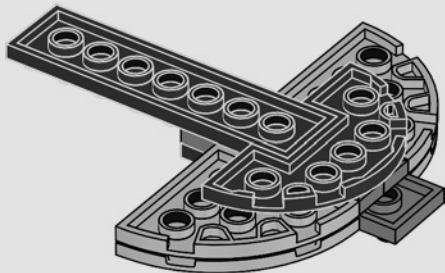



2x

10

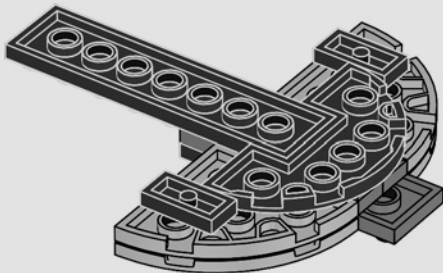



2x



1x

11

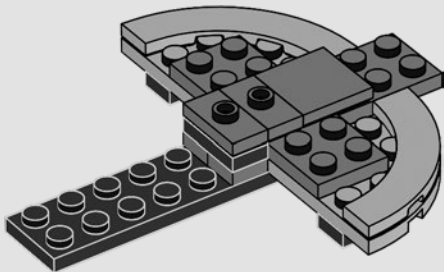
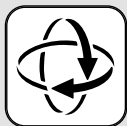

20





2x

12

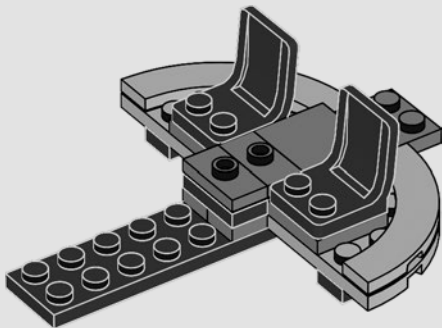



2x



2x

# 13

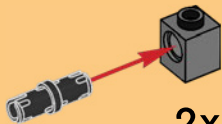

2x

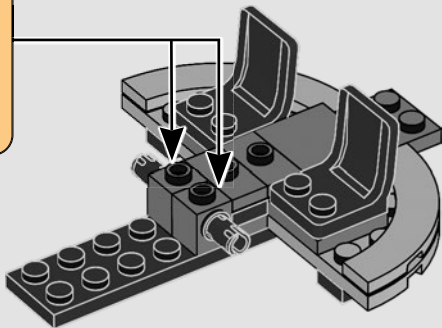



2x

14

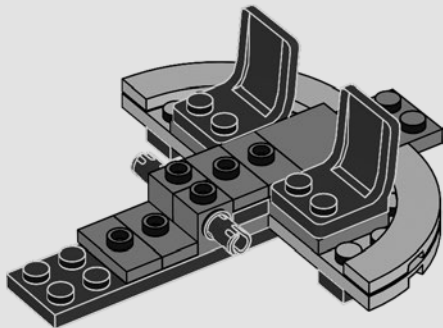



1x

# 15

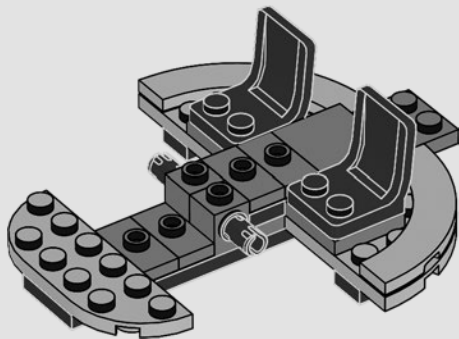





1x



1x

# 16

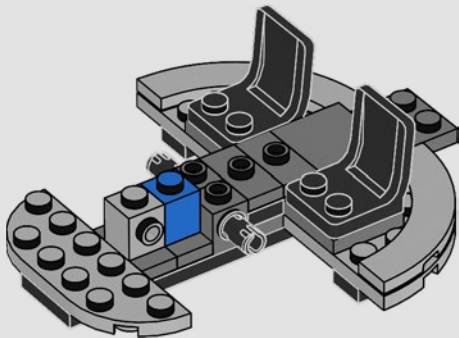



3x

17



3x

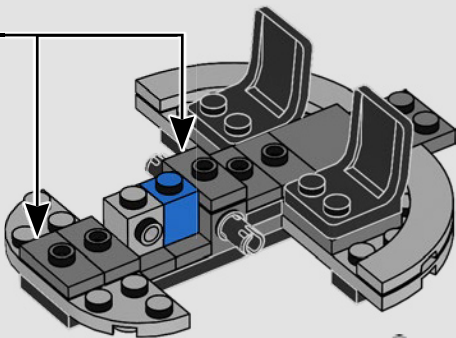



1x

18

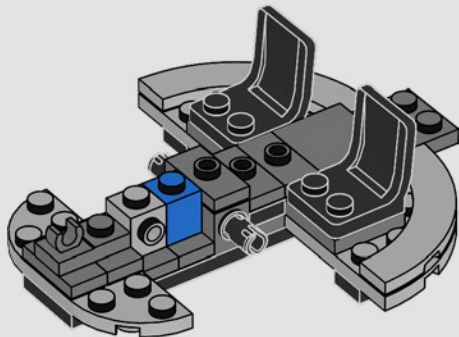



1x



1x

# 19

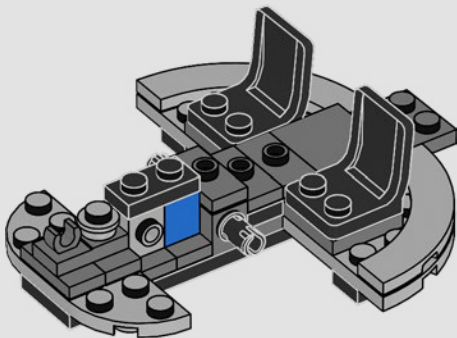



1x



1x

# 20

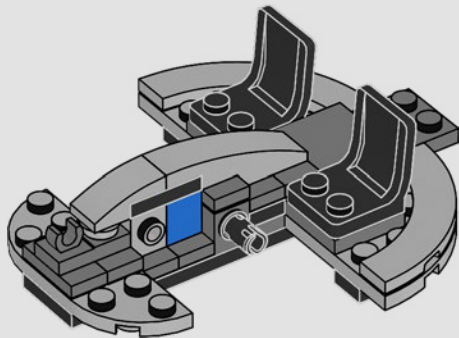

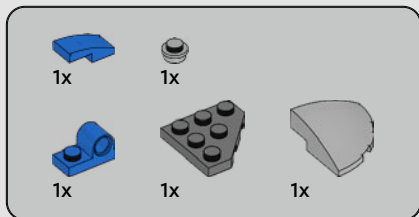

# 21

1

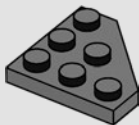

2

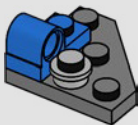

3

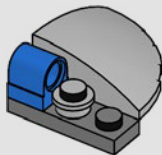

4

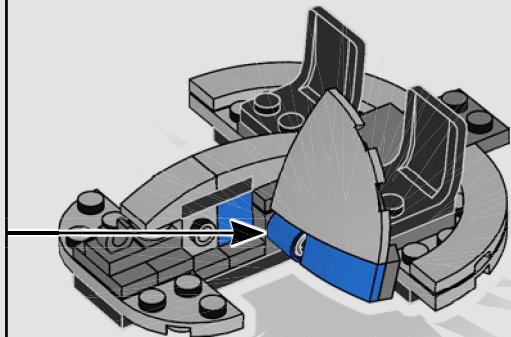
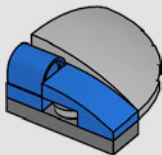

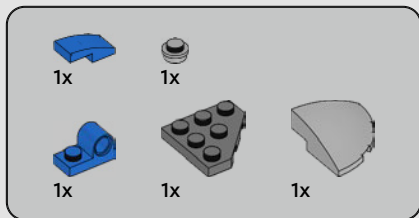

# 22

1

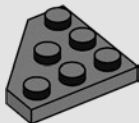

2

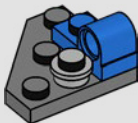

3

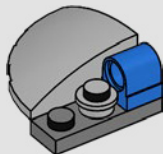



4

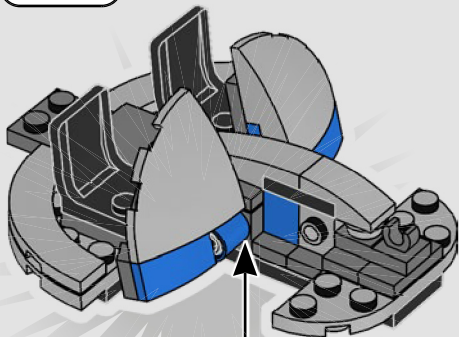
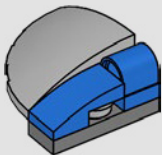



2x



2x



# 23

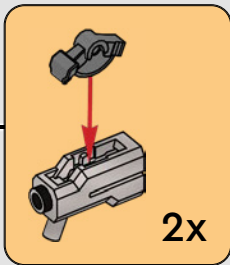
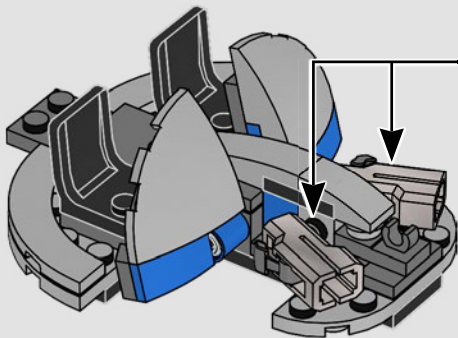



1x

24





2x

25

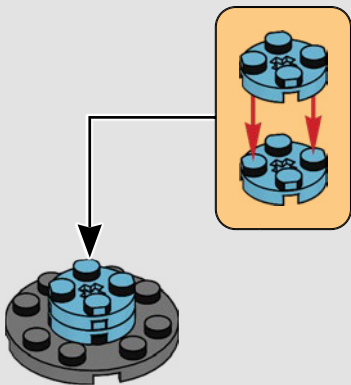



1x

26

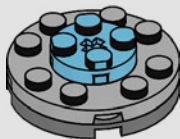



3x



1x

# 27

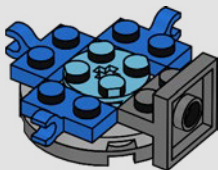

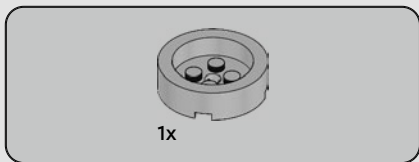

28

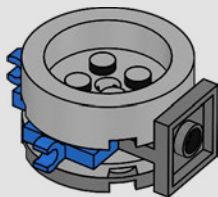

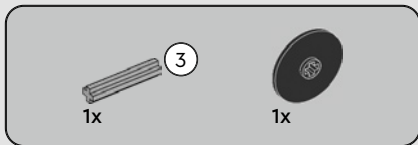

29

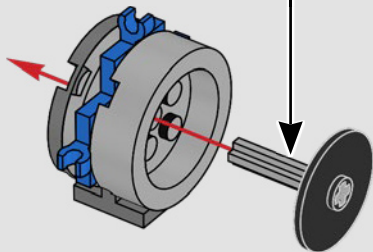
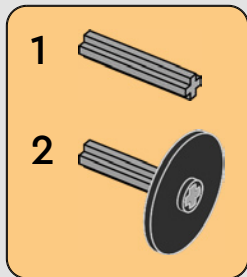



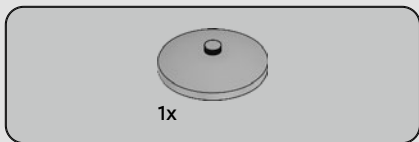

30

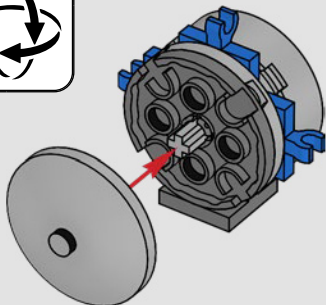

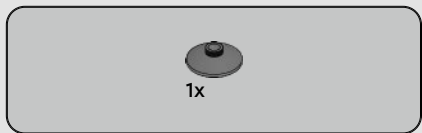

31

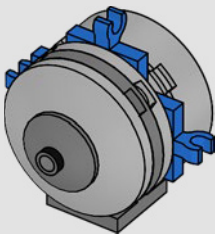



32

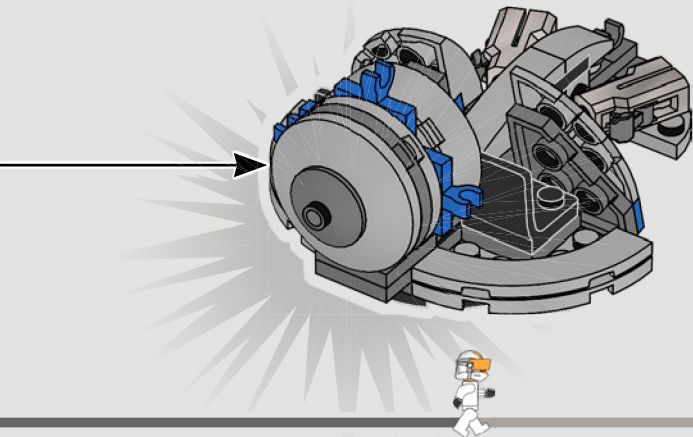

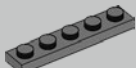
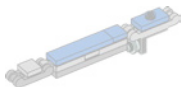

1x

33

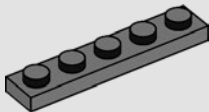



1x



2x

# 34

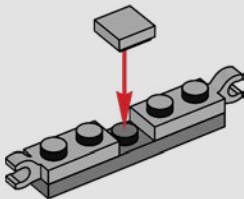



1x



1x

# 35

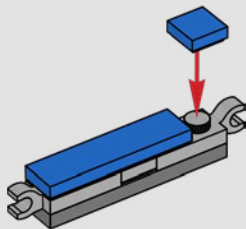



1x



1x

# 36

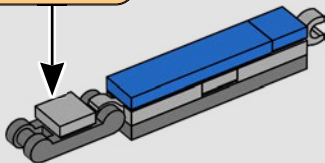
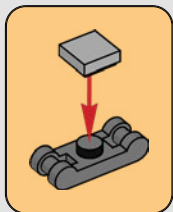

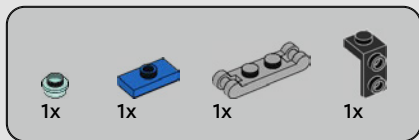

# 37

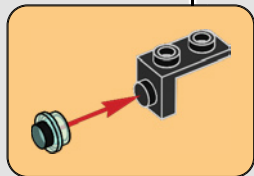
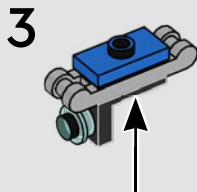
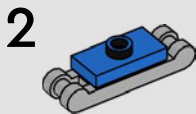
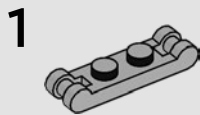



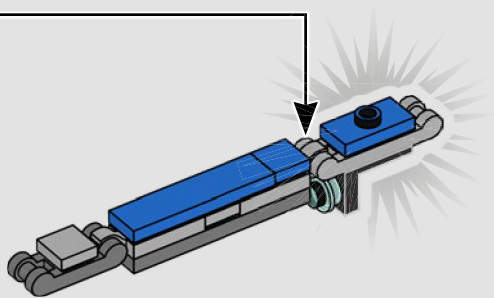

38

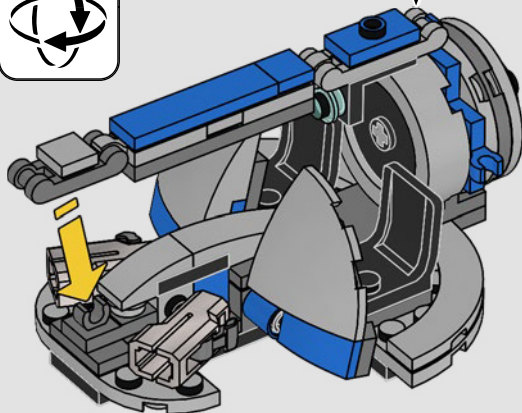

39

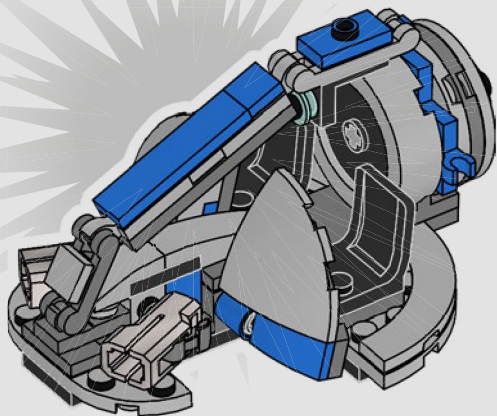



40

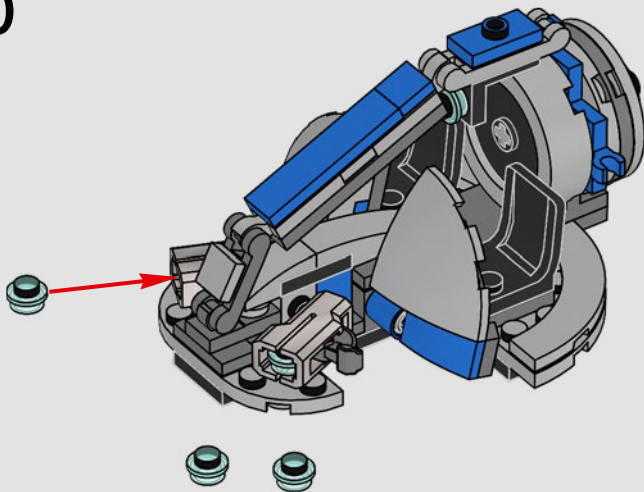

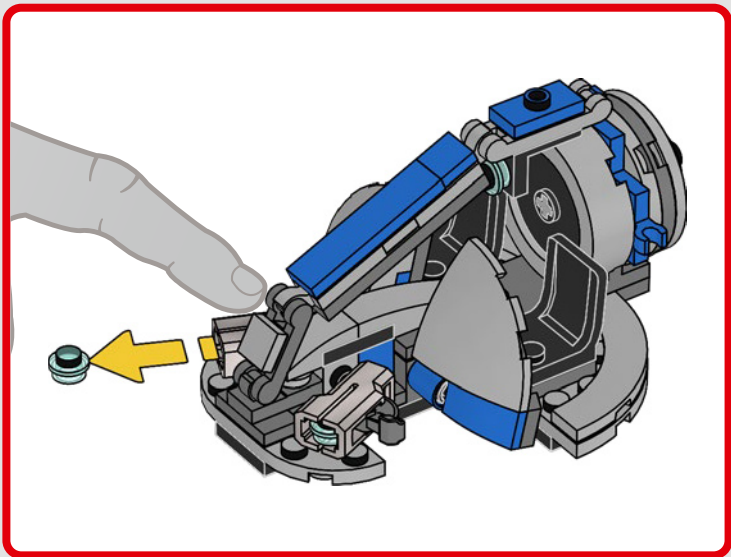

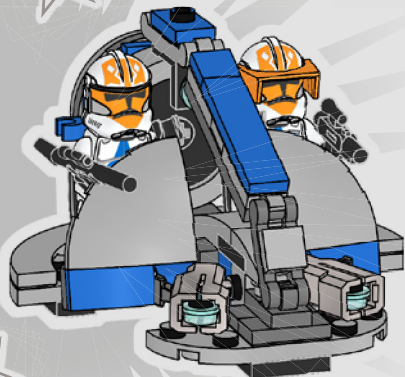



# STAR WARS™



**75360**



**75345**



**75359**



# STAR WARS™



**75368**



**75369**



**75370**





# STAR WARS™



**75346**



**75348**

**75363**



**75344**



**75361**





4x  
6308125



4x  
6444184



1x  
6455989



3x  
6311398



4x  
6308127



1x  
4206330



2x  
6055065



1x  
300523



1x  
6092582



1x  
243123



2x  
6248822



3x  
6313131



2x  
6311462



1x  
6313508



2x  
6279875



4x  
302326



1x  
6380236



3x  
4498713



1x  
4498712



1x  
4218868



2x  
407926



1x  
6138405



1x  
303426

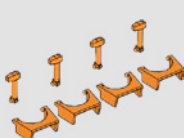

1x  
6464520



2x  
6407412



3x  
4211525



1x  
4213567



2x  
4211415



1x  
6028813



1x  
6042950



2x  
6319336



1x  
6093058



1x  
4211815

3



1x  
4211664



1x  
6167798



1x  
6303438



1x  
6105964



2x  
6163989



2x  
4579294



1x  
6179186



7x  
6240225



2x  
6109752



1x  
6395635



3x  
6360675



2x  
4210639



1x  
4211010



1x  
4211055



7x  
6092572



1x  
6344754



1x  
6352600



1x  
6250018



1x  
4211043



2x  
4210897



1x  
4528323



3x  
6413109



1x  
4211002



3x  
6345879

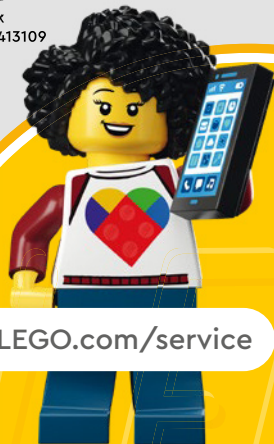

LEGO.com/service

YOU COULD

WIN

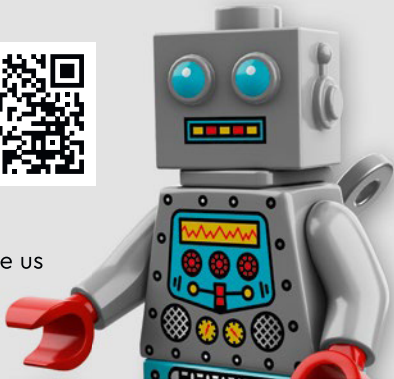

Scan this QR code or go to  
**LEGO.COM/PRODUCTFEEDBACK** and give us  
your short feedback about this LEGO® set  
for a chance to win a cool LEGO prize.

Terms and Conditions apply\*

**EN: YOU COULD WIN.** Terms and Conditions apply\* **DE: Du könntest GEWINNEN.** Es gelten die Teilnahmebedingungen\* **FR: Tu pourrais GAGNER.** Des conditions s'appliquent\* **IT: Potresti VINCERE tu.** Termini e condizioni sono applicabili\* **ES: Puedes GANAR.** Aplican términos y condiciones\* **PT: Poderá GANHAR.** Aplicam-se termos e condições\* **ZH: 轻松获奖.** 条款和条件适用\* **PL: Szansa na WYGRANĄ.** Obowiązują warunki korzystania\* **CS: Máte šanci VYHRÁT.** Platí všeobecné smluvní podmínky\* **SK: Máte šancu VYHRÁŤ.** Platia všeobecné zmluvné podmienky\* **HU: TE IS NYERHETSZ.** Felhasználási feltételek érvényesek\* **RO: Ai putea CÂȘTIGA.** Se aplică termeni și condiții\* **BG: Можете да СПЕЧЕЛИТЕ.** Има определени правила и условия\* **LV: Tu vari LAIMĒT.** Ir spēkā noteikumi un nosacījumi.\* **ET: Sul on võimalus VÕITA.** Kehtivad tingimused\* **LT: Jūs galite LAIMĖTI.** Taikomos sąlygos\*

\*[LEGO.com/productfeedback-terms](https://www.lego.com/productfeedback-terms)

LEGO and the LEGO logo are trademarks of the/son des marques de commerce du/  
son marcas registradas de LEGO Group. ©2023 The LEGO Group.

© & ™ Lucasfilm Ltd.

6475501